



2016/11



AluK Building Systems Private Limited

Bagmane Laurel, "B" Block, 2nd Floor, Level 3
Bagmane Tech Park, CV Raman Nagar
Bangalore-560093, Karnataka, India

T: +91 80 3304 3304
E: info@aluk.in

40N / 45DS

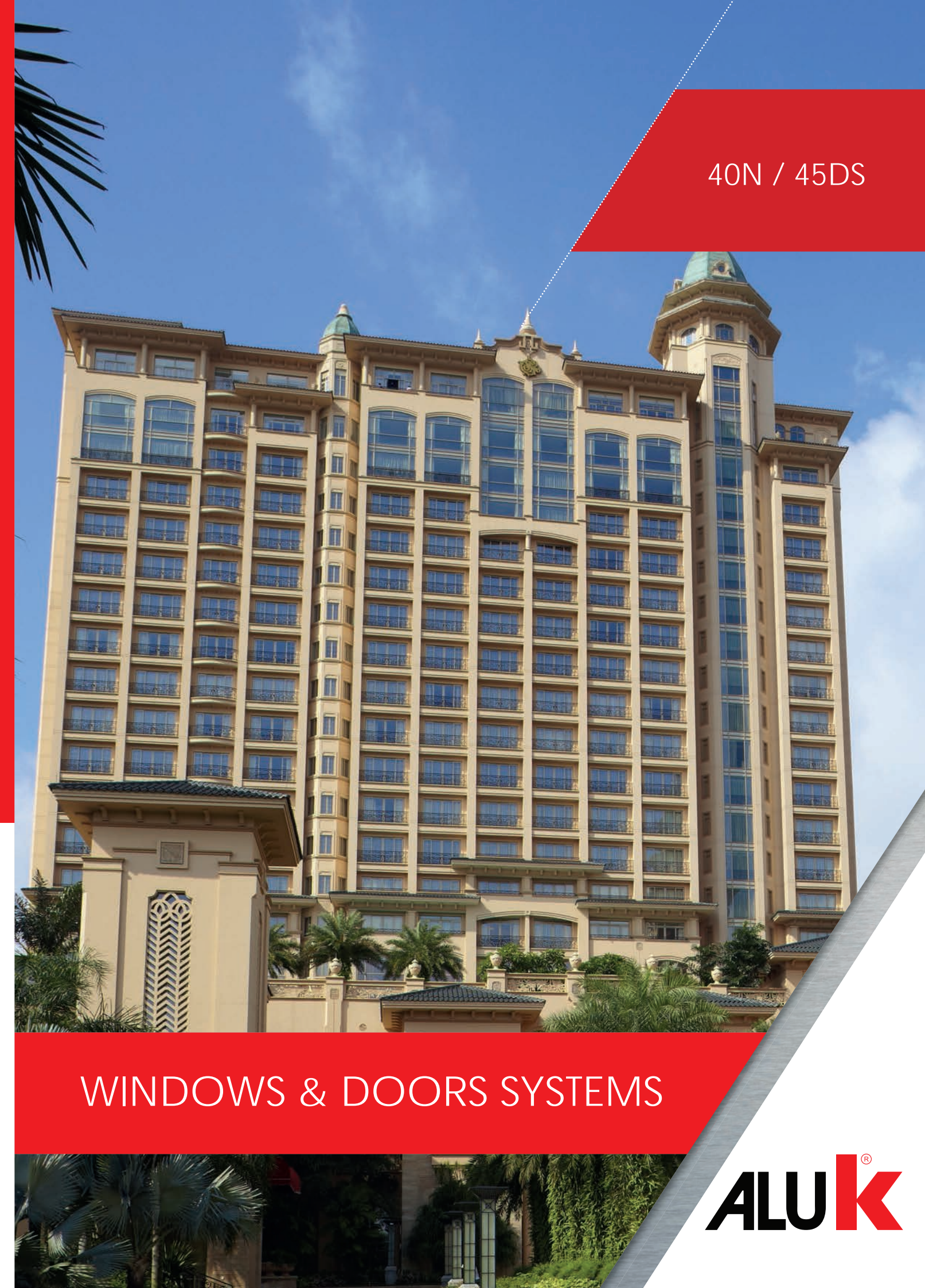

WINDOWS & DOORS SYSTEMS

aluk.in

ALUK[®]

ALUK[®]

40N / 45DS

➤ 40N: AN ECONOMIC AND HIGH QUALITY SYSTEM

AluK 40N is an outward opening casement window solution with a range of high performance product options for single and double glazing of 5 to 36 mm, allowing this system to stand out for its affordability, aesthetics, functionality and performance. Constructed on a 40 mm module, the 40N casement series is available in complete flush or overlap look from inside and comes in both with or without glazing bead option. The system can be easily integrated with AluK SC40 Sliders, and is suitable for both residential and commercial buildings.

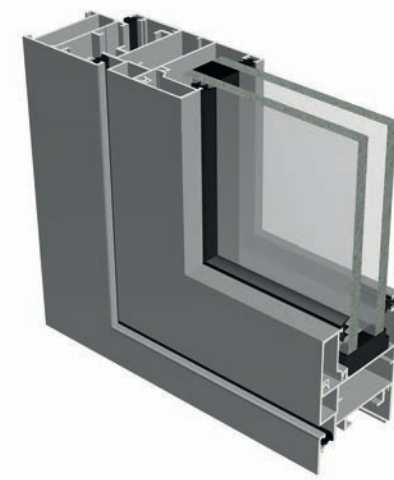

CAD Cross sections

Lateral section without glazing bead

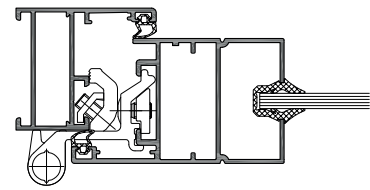

Lateral section with glazing bead

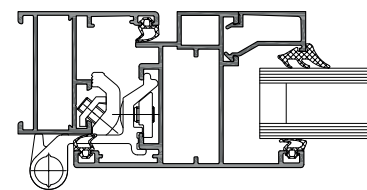

Performances

- Air: 4
- Water: E₇₅₀
- Wind: C4

Test based on a 2-sash window dimension 1220 mm W x 1524 mm H

➤ 45DS: OPTIMIZED DESIGN AND HIGH PERFORMANCE SYSTEM

AluK 45DS casement series is an optimally designed window and door system recognized for its high acoustic and weather performances; making it the ideal solution for exterior joinery in tropical and hot climates. This system is available in a variety of applications: one, two or more sashes, inward and outward opening, tilt and turn, balcony doors, etc. The 45DS comes with outer frame window and door section of 45 mm and allows application of glazing thickness of 5 mm to 30 mm. It can be easily integrated with AluK SC45 slider.



CAD Cross sections

Lateral section inward opening

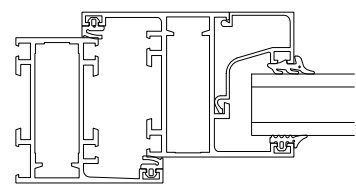

Lateral section outward opening

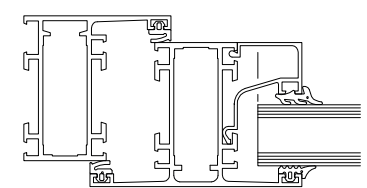

Performances

- Air: 3
- Water: 4
- Wind: 3

Test based on a 1-sash window dimension 1043 mm W x 1442 mm H

Applications

40N

Open-out

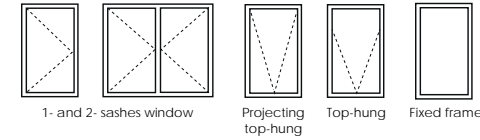

Composite frames

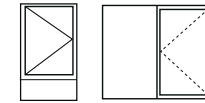

45DS

Open-in



Open-out

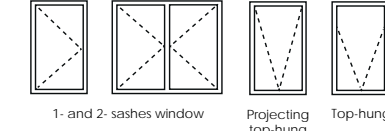

Composite frames

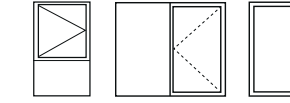

Configurations

The wide range of casement option available are:

- fixed window,
- side hung open outside in single or double sashes windows,
- side hung open inside in single or double sashes windows (45DS),
- tilt & turn windows (45DS),
- top & bottom hung windows,
- multiple sashes (45DS),
- patio doors (45DS),
- fixed light or sliders integration option.

High quality extrusions, fittings & accessories

The extruded aluminium sections are made from 6063 alloy homogenized billets with aluminium composition tolerances and suited for anodizing and painting. Wide range of anodized and powder coated finish available with RAL color choices warranted for 10/25 years.

A comprehensive spectrum of high quality AluK branded fittings and accessories with ergonomic handles, multipoint locks and invisible fastening points, best quality microwave cured EPDM gaskets and other accessories tested for large cycles of window operation.

Product Features

	40N	45DS
Frame depth	40 mm	45 mm
Aesthetic	Overlap / Internal flush	Overlap
Shutter depth	41 / 51 mm	45 mm
Infill glass thickness	Fix frame : 5 - 26 mm Opening frame : 5 - 36 mm	Fix & opening frame: 5 - 30 mm
Frame and shutter assembly	45° joint in frame & shutter	45° joint in frame & shutter
Multipoint locking	●	●
Hurricane barrier	●	●
Butt hinge and friction hinge	●	●
Sealing system	Double gasket	Double gasket
Handle	Cremona	Cremona
Slider compatibility	SC40	SC45
Doors		●
Shutter opening	Outside	Inside or outside
Glass fixing	With/without glazing beads	With glazing bead

